

BUFFET



MAKE SURE
IT'S RAK





MAKE SURE IT'S RAK

TABLE OF CONTENTS

En This catalogue is the working instrument of all RAK Porcelain distribution channels. The availability of certain products may vary depending on countries. Please check the availability of the products you would like to purchase with the distributor/importer of RAK Porcelain in your area. Current prices apply.

Es Este catálogo es la herramienta de trabajo de todos los circuitos de distribución de RAK Porcelain. La disponibilidad de determinados productos puede variar en función de los países. Les rogamos que comprueben, con el distribuidor/importador de RAK Porcelain de su región, la disponibilidad de los productos que deseen adquirir. Los precios actuales sirven de referencia.

Fr Ce catalogue est l'outil de travail de tous les circuits de distribution RAK Porcelaine. La disponibilité de certains produits pourrait varier selon les pays. Veuillez vérifier auprès du distributeur/importateur de RAK Porcelaine de votre région, la disponibilité des produits que vous aimeriez acquérir. Les tarifs actuels font référence.

It Il presente catalogo rappresenta lo strumento di lavoro di tutti i circuiti di distribuzione di RAK Porcelain. La disponibilità di alcuni prodotti può variare in base al paese. Vi preghiamo pertanto di verificare la disponibilità dei prodotti che desiderate acquistare presso il distributore o l'importatore RAK Porcelain e di fare riferimento alle tariffe attuali.

De Dieser Katalog ist die Arbeitsgrundlage für sämtliche Vertriebstätigkeiten von RAK Porzellan. Die Verfügbarkeit einiger Produkte kann je nach Land variieren. Bitte prüfen Sie bei dem für Ihre Region zuständigen Vertriebspartner bzw. Importeur von RAK Porzellan, ob die von Ihnen gewünschten Produkte verfügbar sind. Maßgeblich ist die aktuelle Preisliste.

4 Buffet

6 Colors

8 Large dishes

20 Medium dishes

26 Small dishes

34 Gastronorm dishes

40 Buffet Systems

46 Service accessories



En Play around with the BUFFET sets - these fun solutions created by RAK Porcelain offer you a range of service capacities, from the biggest sizes to miniature ones. BUFFET is ready to serve at any time, with all the features you need for serving cocktails, breakfasts, hot or cold buffets and cocktail dinners, as well as all items compatible with the "gastronorm" system.

Choose from a wide range of material and colour effects, the result of work by the Research & Development department. RAK Porcelain has achieved unique technical prowess in developing many innovations, such as NEOFUSION, TWIRL, and GENESIS glazes.

Our decorating techniques respect strict and exacting specifications to better exceed customer expectations. The durability of surfaces remains assured when it comes to scratches, repeated stacking, and frequent contact with detergents and food products. All hygiene standards in force are scrupulously observed, particularly concerning inks and coloured glazes.

Fr Jouez avec les assortiments BUFFET, ses solutions ludiques créées par RAK Porcelaine vous offrent un panel de contenances, des plus grandes tailles jusqu'aux miniatures. BUFFET sert à toutes heures, avec toutes les fonctions nécessaires au service de cocktails, petits déjeuners, buffets chauds ou froids et cocktails dinatoires, équipé de l'ensemble des articles compatibles avec le système «gastronorm».

Choisissez parmi une vaste palette d'effets de matières et de coloris, fruit du travail du département de Recherche & Développement. RAK Porcelaine a réalisé des prouesses techniques uniques pour développer tant de nouveautés, comme les glaçures NEOFUSION, TWIRL ou GENESIS.

Les techniques de décoration respectent un cahier des charges strict et exigeant pour mieux dépasser les attentes des utilisateurs. La durabilité des surfaces reste assurée quant aux rayures, empilements répétés, contacts fréquents avec produits lessiviels et alimentaires. Toutes les normes d'hygiène en vigueur sont scrupuleusement suivies particulièrement concernant les encres et glaçures colorées.

De Setzen Sie auf die von RAK Porzellan kreierten BUFFET-Produktreihen, deren ansprechende Lösungen Ihnen eine Auswahl mit unterschiedlichem Fassungsvermögen, von groß bis hin zur Miniatur, bieten. BUFFET kann zu jeder Tageszeit verwendet werden und verfügt über alle erforderlichen Funktionalitäten für das Servieren von Cocktails, Frühstück, kalten oder warmen Büfets und Dinner-Cocktails sowie über sämtliche, mit dem System „Gastronorm“ kompatiblen Artikel.

Wählen Sie aus einem breiten Angebot an Material- und Farbeffekten, Ergebnis der Arbeit der Abteilung Forschung und Entwicklung. RAK Porzellan hat für die Entwicklung von zahlreichen Neuheiten, wie die Glasuren NEOFUSION, TWIRL oder GENESIS, einzigartige, technische Höchstleistungen vollbracht.

Um die Erwartungen der Verbraucher noch zu übertreffen, unterliegt die Gestaltungstechnik einem strikten und anspruchsvollen Pflichtenheft. Die Haltbarkeit der Oberflächen in Bezug auf Kratzer, wiederholtes Stapeln, häufigen Kontakt mit Spül- und Lebensmitteln bleibt gewährleistet. Alle geltenden Hygienestandards werden insbesondere hinsichtlich der farbigen Tinten und Glasuren strikt eingehalten.

Es Diviértase con los conjuntos BUFFET. Con sus soluciones lúdicas, RAK Porcelain le ofrece toda la variedad que pueda necesitar, desde los mayores tamaños hasta las miniaturas. BUFFET es funcionalidad a todas horas, con las cualidades necesarias para el servicio de cócteles, desayunos, bufets calientes o fríos y cenas informales, así como el conjunto de artículos compatibles con el sistema "gastronorm".















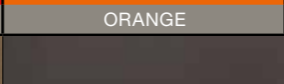









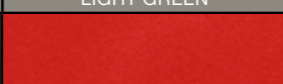

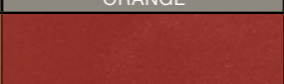
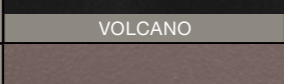

Elija entre una extensa paleta de efectos matéricos y cromáticos, fruto del trabajo del Departamento de Investigación y Desarrollo. RAK Porcelain ha realizado proezas técnicas sin igual en el desarrollo de sus numerosas novedades, como los vidriados NEOFUSION, TWIRL o GENESIS.

Las técnicas de decoración cumplen un pliego de condiciones estricto y exigente para superar con holgura las expectativas de los usuarios. La durabilidad de sus superficies está asegurada gracias a su resistencia ante los arañazos, el apilamiento reiterado y el contacto frecuente con productos alimentarios y de lavado. Se respetan escrupulosamente todas las normas de higiene en vigor; en particular, las relativas a las tintas y los vidriados coloridos.

It Giocate con le collezioni BUFFET, le soluzioni ludiche create da RAK Porcelain offrono le più variate dimensioni, dalle misure più grandi alle più piccole. BUFFET è l'ideale per tutte le pietanze della giornata, soddisfacendo alla perfezione le esigenze del servizio cocktail, della colazione, del buffet caldo o freddo e dell'aperitivo, inoltre adempie al set di articoli compatibili con il sistema «gastronorm».

Scegliete attraverso una vasta gamma di effetti di materie e di colori, frutto del lavoro del nostro dipartimento di ricerca e sviluppo. RAK Porcelain ha realizzato prodezze tecniche uniche per sviluppare tantissime novità, come i rivestimenti NEOFUSION, TWIRL o GENESIS.

Le pratiche di decorazione rispettano rigorosamente le specifiche tecniche per superare al meglio le aspettative degli utenti. La resistenza delle superfici è garantita per quanto riguarda graffi, sovrapposizioni ripetute e frequenti contatti con detersivi e alimenti. Tutte le norme d'igiene applicate vengono seguite scrupolosamente, in particolar modo per ciò che riguarda gli inchiostri e i rivestimenti colorati.

IVORIS						
POLARIS						
FIRE						
	GREEN	RED	ORANGE			
GENESIS MAT						
	ALMOND	CRUST	COCOA			
KARBON / SUGGESTIONS - SHAPED						
LEA						
	BLUE	LIGHT GREEN	RED	ORANGE	YELLOW	
NEOFUSION / CHEF'S FUSION / SUGGESTIONS - SHARED/STAGED						
	VOLCANO	EMBER	TERRA	MAGMA	STONE	SAND
NEOFUSION MELLOW						
	CHESNUT BROWN	PITAYA GREY	ORCHID LAVENDER	PLUM PURPLE		
SHALE						
TRINIDAD						
	GREY	WALNUT	CEDAR			
TWIRL						
	BEACH	SHELL	ALGA	CORAL	LAGOON	
VINTAGE						
	WHITE	GREEN	BLUE	PINK		
WILD						
WOODART						
	BEACH GREY	MOSS GREEN	TIMBER BROWN	OAK BROWN		

En Please find below various decorations available for specific items in this collection.

Es A continuación le presentamos las diferentes decoraciones disponibles para algunos artículos de esta colección.

Fr Vous trouverez ci-dessous les différents décors proposés sur certains articles de cette collection.

It Di seguito, troverete le diverse decorazioni proposte su alcuni articoli di questa collezione.

De Nachstehend erhalten Sie einen Überblick über die verschiedenen, auf einigen Artikeln dieser Kollektion angebotenen Dekore.

LARGE DISHES

En

Functional, safe, and robust, the LARGE DISHES series offers a multitude of culinary presentations, even including extra-large quantities.

Fr

Fonctionnels, sûrs et robustes, les grands plats offrent une multitude de présentations culinaires, jusque dans les plus grands volumes.

De

Funktionell, sicher und robust bieten die großen Schalen zahlreiche Möglichkeiten für die Präsentation von Speisen, auch in großem Umfang.

Es

Funcionales, seguras y robustas, las fuentes grandes permiten una multitud de presentaciones culinarias, incluso con los mayores volúmenes.

It

Funzionali, sicuri e robusti, i piatti grandi offrono molteplici presentazioni culinarie, anche in quantità ingenti.



Round cocotte & lid
Cocotte ronde & couvercle
Cocotte rund & Deckel
Cocotte redonda & tapa
Cocotte rotonda & coperchio

28 cm - 17 cm - 460 cl
11" - 6.70" - 155.55 oz

CHEF'S FUSION

■ CFRD28BK
■ CFRD28BR
■ CFRD28GY

1

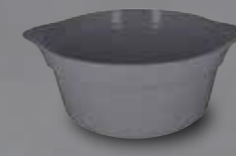

Round cocotte
Cocotte ronde
Cocotte rund
Cocotte redonda
Cocotte rotonda

28 cm - 12 cm - 460 cl
11" - 4.70" - 155.55 oz

CHEF'S FUSION

■ CFRD28BKBD
■ CFRD28BRBD
■ CFRD28GYBD

1



Lid for round cocotte
Couvercle pour cocotte ronde
Deckel für Cocotte rund
Tapa para cocotte redonda
Coperchio per cocotte rotonda

28 cm - 5 cm
11" - 1.95"

CHEF'S FUSION

■ CFRD28BKLD
■ CFRD28BRLD
■ CFRD28GYLD

4

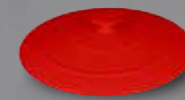

Oval dish
Plat ovale
Platte oval
Fuente oval
Vassoio ovale

BUOP56 56 x 21 x 5.5 cm - 220 cl
22.05 x 8.25 x 2.15" - 74.40 oz

1



Oval platter
Plat ovale
Platte oval
Fuente oval
Piatto oval

36.5 x 25 cm - 6 cm - 280 cl
14.35 x 9.85" - 2.35" - 94.70 oz

CHEF'S FUSION

■ CFOD44BKBD
■ CFOD44BRBD
■ CFOD44GYBD

3



Lid for oval platter
Couvercle pour plat ovale
Deckel für Platte oval
Tapa para fuente oval
Coperchio per piatto oval

37.2 x 25 cm - 3 cm
14.65 x 9.85" - 1.20"

CHEF'S FUSION

■ CFOD44BKLD
■ CFOD44BRLD
■ CFOD44GYLD

3



For more details and to make your choice among colours and textures, please go to pages 6 and 7.
Pour plus de détails et faire votre choix parmi les couleurs et les textures, rendez-vous en pages 6 et 7.
Weitere Informationen und eine Auswahl an Farben und Strukturen finden Sie auf den Seiten 6 und 7.
Si desea más información o opciones en colores y texturas, por favor, consulte las páginas 6 y 7.
Per maggiori dettagli e per fare la tua scelta tra colori e trame vai alle pagine 6 e 7.



Oval platter

Plat ovale
Platte oval
Fuente oval
Piatto oval
30 x 21 cm - 6 cm - 204 cl
11.80 x 8.25" - 2.35" - 69 oz

CHEF'S FUSION

- CFOD37BKBD
- CFOD37BRBD
- CFOD37GYBD



Stackable rectangular long dish

Plat rectangulaire long empilable
Schale rechteckig lang stapelbar
Plato rectangular largo apilable
Coppetta lunga rettangolare impilabile

LXRB47 47 x 20 x 6 cm
18.50 x 7.85 x 2.35"



Lid for oval platter

Couvercle pour plat ovale
Deckel für Platte oval
Tapa para fuente oval
Coperchio per piatto oval

31 x 21 cm - 3 cm
12.20 x 8.25" - 1.20"

CHEF'S FUSION

- CFOD37BKLD
- CFOD37BRLD
- CFOD37GYLD



Twin plate

Plat twin
Platte twin
Plato doble twin
Piatto twin

MZTP32 32 x 10 cm
12.60 x 3.95"



Ellipse plate

Plat ellipse
Platte elipse
Plato elipse
Piatto ellisse

MZEP32 32 x 21 cm
12.60 x 8.25"



Oval platter

Plat ovale
Platte oval
Fuente oval
Piatto oval
25.5 x 17.5 cm - 5.5 cm - 120 cl
10 x 6.90" - 2.15" - 40.60 oz

CHEF'S FUSION

- CFOD31BKBD
- CFOD31BRBD
- CFOD31GYBD



Lid for oval platter

Couvercle pour plat ovale
Deckel für Platte oval
Tapa para fuente oval
Coperchio per piatto oval

26 x 17.5 cm - 3 cm
10.25 x 6.90" - 1.20"

CHEF'S FUSION

- CFOD31BKLD
- CFOD31BRLD
- CFOD31GYLD



Rectangular tureen

Terrine rectangulaire
Terrine rechteckig
Tarrina rectangular
Terrina rettangolare

38 x 24.5 cm - 6 cm - 400 cl
14.95 x 9.65" - 2.35" - 135.25oz

CHEF'S FUSION

- CFRT39BKBD
- CFRT39BRBD
- CFRT39GYBD



Lid rectangular tureen

Couvercle pour terrine rectangulaire
Deckel für Terrine rechteckig
Tapa para tarrina rectangular
Coperchio per terrina rettangolare

39.5 x 24.5 cm - 3 cm
15.55 x 9.65" - 1.20"

CHEF'S FUSION

- CFRT39BKLD
- CFRT39BRLD
- CFRT39GYLD

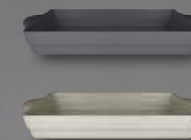

Rectangular tureen

Terrine rectangulaire
Terrine rechteckig
Tarrina rectangular
Terrina rettangolare

31.5 x 22 cm - 6 cm - 283 cl
12.40 x 8.65" - 2.35" - 95.70 oz

CHEF'S FUSION

- CFRT32BKBD
- CFRT32BRBD
- CFRT32GYBD



Lid rectangular tureen

Couvercle pour terrine rectangulaire
Deckel für Terrine rechteckig
Tapa para tarrina rectangular
Coperchio per terrina rettangolare

32.5 x 22 cm - 2.3 cm
12.80 x 8.65" - 0.90"

CHEF'S FUSION

- CFRT32BKLD
- CFRT32BRLD
- CFRT32GYLD



For more details and to make your choice among colours and textures, please go to pages 6 and 7.
Pour plus de détails et faire votre choix parmi les couleurs et les textures, rendez-vous en pages 6 et 7.
Weitere Informationen und eine Auswahl an Farben und Strukturen finden Sie auf den Seiten 6 und 7.
Si desea más información o opciones en colores y texturas, por favor, consulte las páginas 6 y 7.
Per maggiori dettagli e per fare la tua scelta tra colori e trame vai alle pagine 6 e 7.



Asymmetric bowl
 Bol asymétrique
 Schale asymmetrisch
 Bol asimétrico
 Coppetta asimmetrica
BUBA29 29 cm - 14 cm - 160 cl
 11.40" - 5.50" - 54.10 oz
 1



Bowl
 Bol
 Schale
 Bol
 Coppetta
NAMB31 31 cm - 8 cm - 95 cl
 12.20" - 3.15" - 32.10 oz
 6



Asymmetric bowl
 Bol asymétrique
 Schale asymmetrisch
 Bol asimétrico
 Coppetta asimmetrica
 29 cm - 14 cm - 160 cl
 11.40" - 5.50" - 54.10 oz



TWIRL
 TWBUBA29BE
 TWBUBA29SH
 TWBUBA29AL
 TWBUBA29CO
 TWBUBA29LA
 1



Deep coupe plate
 Assiette creuse coupe
 Teller tief coup
 Plato hondo coupe
 Piatto fondo senza falda
BUBC46 46 cm - 4 cm - 575 cl
 18.10" - 1.55" - 194.45 oz
BUBC36 36 cm - 4 cm - 360 cl
 14.15" - 1.55" - 121.75 oz
 1



Deep coupe plate
 Assiette creuse coupe
 Teller tief coup
 Plato hondo coupe
 Piatto fondo senza falda
 36 cm - 4 cm - 360 cl
 14.15" - 1.55" - 121.75 oz
TWIRL
 TWBUBC36BE
 TWBUBC36SH
 TWBUBC36AL
 TWBUBC36CO
 TWBUBC36LA
 1



Asymmetric bowl
 Bol asymétrique
 Schale asymmetrisch
 Bol asimétrico
 Coppetta asimmetrica
BUBA22 22 cm - 9 cm - 65 cl
 8.65" - 3.55" - 22 oz
 1



Asymmetric bowl
 Bol asymétrique
 Schale asymmetrisch
 Bol asimétrico
 Coppetta asimmetrica
 22 cm - 9 cm - 65 cl
 8.65" - 3.55" - 22 oz



TWIRL
 TWBUBA22BE
 TWBUBA22SH
 TWBUBA22AL
 TWBUBA22CO
 TWBUBA22LA
 1

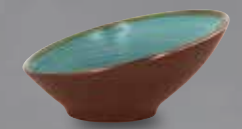

Deep coupe plate
 Assiette creuse coupe
 Teller tief coup
 Plato hondo coupe
 Piatto fondo senza falda
 30 cm - 190 cl
 11.80" - 64.25 oz



TRINIDAD
 TRNNDC31BG
 TRNNDC31BW
 TRNNDC31BC
 6



Deep coupe plate
 Assiette creuse coupe
 Teller tief coup
 Plato hondo coupe
 Piatto fondo senza falda
WILD
WLNND31 30 cm - 190 cl
 11.80" - 64.25 oz
 6



Deep coupe plate
 Assiette creuse coupe
 Teller tief coup
 Plato hondo coupe
 Piatto fondo senza falda
BUBC30 30 cm - 190 cl
 11.80" - 64.25 oz
 6



Deep coupe plate
 Assiette creuse coupe
 Teller tief coup
 Plato hondo coupe
 Piatto fondo senza falda
BUBC30 30 cm - 190 cl
 11.80" - 64.25 oz
 6



Deep coupe plate
 Assiette creuse coupe
 Teller tief coup
 Plato hondo coupe
 Piatto fondo senza falda
 30 cm - 190 cl
 11.80" - 64.25 oz



NEOFUSION
 NFBUBC30BK
 NFBUBC30BR
 NFBUBC30DR
 NFBUBC30GY
 NFBUBC30WH
 6



Deep coupe plate
 Assiette creuse coupe
 Teller tief coup
 Plato hondo coupe
 Piatto fondo senza falda
 30 cm - 190 cl
 11.80" - 64.25 oz



TWIRL
 TWBUBC30BE
 TWBUBC30SH
 TWBUBC30AL
 TWBUBC30CO
 TWBUBC30LA
 6



For more details and to make your choice among colours and textures, please go to pages 6 and 7.
 Pour plus de détails et faire votre choix parmi les couleurs et les textures, rendez-vous en pages 6 et 7.
 Weitere Informationen und eine Auswahl an Farben und Strukturen finden Sie auf den Seiten 6 und 7.
 Si desea más información o opciones en colores y texturas, por favor, consulte las páginas 6 y 7.
 Per maggiori dettagli e per fare la tua scelta tra colori e trame vai alle pagine 6 e 7.



Deep coupe plate
Assiette creuse coupe
Teller tief coup
Plato hondo coupe
Piatto fondo senza falda

30 cm - 190 cl
11.80" - 64.25 oz

VINTAGE

- VNBUBC30WH
- VNBUBC30GR
- VNBUBC30BL
- VNBUBC30PK

6

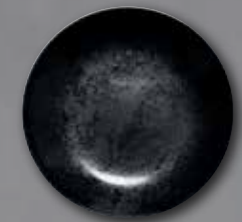

Deep coupe plate
Assiette creuse coupe
Teller tief coup
Plato hondo coupe
Piatto fondo senza falda

KARBON

KRNNDP28 28cm - 125 cl
11" - 42.25 oz

12



Deep coupe plate
Assiette creuse coupe
Teller tief coup
Plato hondo coupe
Piatto fondo senza falda

SHALE

SHNNDP28 28cm - 125 cl
11" - 42.25 oz

12



Deep coupe plate
Assiette creuse coupe
Teller tief coup
Plato hondo coupe
Piatto fondo senza falda

28 cm - 125 cl
11" - 42.25 oz

GENESIS MAT

- GNNNDP28AL
- GNNNDP28CR
- GNNNDP28CO

12



Deep coupe plate
Assiette creuse coupe
Teller tief coup
Plato hondo coupe
Piatto fondo senza falda

28 cm - 125 cl
11" - 42.25 oz

TWIRL

- TWNNDP28BE
- TWNNDP28SH
- TWNNDP28AL
- TWNNDP28CO
- TWNNDP28LA

12



NEW

Deep coupe plate
Assiette creuse coupe
Teller tief coup
Plato hondo coupe
Piatto fondo senza falda

28 cm - 125 cl
11" - 42.25 oz

TRINIDAD

- TRNNDP28BG
- TRNNDP28BW
- TRNNDP28BC

12



NEW

Deep coupe plate
Assiette creuse coupe
Teller tief coup
Plato hondo coupe
Piatto fondo senza falda

28 cm - 125 cl
11" - 42.25 oz

FIRE

- FRNNDP28GR
- FRNNDP28RD
- FRNNDP28OR

12



Deep coupe plate
Assiette creuse coupe
Teller tief coup
Plato hondo coupe
Piatto fondo senza falda

BUBC26 26 cm - 120 cl
10.25" - 40.60 oz

12

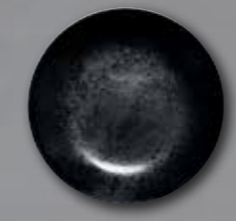

Deep coupe plate
Assiette creuse coupe
Teller tief coup
Plato hondo coupe
Piatto fondo senza falda

KARBON

KRBUBC26 26 cm - 120 cl
10.25" - 40.60 oz

12



Deep coupe plate
Assiette creuse coupe
Teller tief coup
Plato hondo coupe
Piatto fondo senza falda

SHALE
SHBUBC26 26 cm - 120 cl
10.25" - 40.60 oz

12



Deep coupe plate
Assiette coupe creuse
Teller tief coup
Plato hondo coupe
Piatto fondo senza falda

26 cm - 120 cl
10.25" - 40.60 oz

NEOFUSION

- NFBUBC26BK
- NFBUBC26BR
- NFBUBC26BW
- NFBUBC26DR
- NFBUBC26GY
- NFBUBC26WH

12



Deep coupe plate
Assiette coupe creuse
Teller tief coup
Plato hondo coupe
Piatto fondo senza falda

26 cm - 120 cl
10.25" - 40.60 oz

NEOFUSION MELLOW

- NFBUBC26CB
- NFBUBC26PG
- NFBUBC26OL
- NFBUBC26PP

12



For more details and to make your choice among colours and textures, please go to pages 6 and 7.
Pour plus de détails et faire votre choix parmi les couleurs et les textures, rendez-vous en pages 6 et 7.
Weitere Informationen und eine Auswahl an Farben und Strukturen finden Sie auf den Seiten 6 und 7.
Si desea más información o opciones en colores y texturas, por favor, consulte las páginas 6 y 7.
Per maggiori dettagli e per fare la tua scelta tra colori e trame vai alle pagine 6 e 7.



Deep coupe plate
Assiette creuse coupe
Teller tief coup
Plato hondo coupe
Piatto fondo senza falda

26 cm - 120 cl
10.25" - 40.60 oz

GENESIS MAT

- GNBUBC26AL
- GNBUBC26CR
- GNBUBC26CO

12

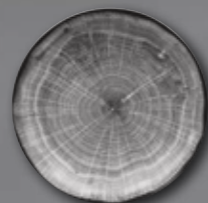

Deep coupe plate
Assiette creuse coupe
Teller tief coup
Plato hondo coupe
Piatto fondo senza falda

26 cm - 120 cl
10.25" - 40.60 oz

WOODART

- WDBUBC26BG
- WDBUBC26MG
- WDBUBC26TB
- WDBUBC26OB

12



Deep coupe plate
Assiette creuse coupe
Teller tief coup
Plato hondo coupe
Piatto fondo senza falda

26 cm - 120 cl
10.25" - 40.60 oz

TWIRL

- TWBUBC26BE
- TWBUBC26SH
- TWBUBC26AL
- TWBUBC26CO
- TWBUBC26LA

12



Deep coupe plate
Assiette creuse coupe
Teller tief coup
Plato hondo coupe
Piatto fondo senza falda

26 cm - 120 cl
10.25" - 40.60 oz

LEA

- LEBUBC26BL
- LEBUBC26LG
- LEBUBC26RD
- LEBUBC26OR
- LEBUBC26NY

12



Deep coupe plate
Assiette creuse coupe
Teller tief coup
Plato hondo coupe
Piatto fondo senza falda

26 cm - 120 cl
10.25" - 40.60 oz

VINTAGE

- VNBUBC26WH
- VNBUBC26GR
- VNBUBC26BL
- VNBUBC26PK

12



Square bowl
Bol carré
Schale quadratisch
Bol cuadrado
Coppetta quadrata

BUBS25 25 cm - 416 cl
9.85" - 140.65 oz

BUBS23 23 cm - 300 cl
9.05" - 101.45 oz

BUBS21 21 cm - 200 cl
8.25" - 67.65 oz

1



Salad bowl xxl
Saladier xxl
Salatschale xxl
Ensaladera xxl
Insalatiera xxl

BUSB31 31 cm - 17 cm - 600 cl
12.20" - 6.70" - 202.90 oz

1



Rectangular tray
Plat rectangulaire
Platte rechteckig
Fuente rectangular
Vassoio rettangolare

BURT52 52 x 24 cm
20.45 x 9.45"

6



Sandwich tray
Plat à sandwich
Sandwichplatte
Bandeja sándwich
Vassoio sandwich

OPST39 39 x 28 cm
15.35 x 11"

6

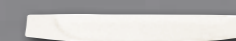

Baguette tray
Plat baguette
Platte baguette
Bandeja baguette
Vassoio baguette

MZBP50 50 x 11 cm
19.70 x 4.35"

MZBP44 44 x 10.5 cm
17.30 x 4.15"

MZBP38 38 x 10 cm
14.95 x 4"

6



For more details and to make your choice among colours and textures, please go to pages 6 and 7.
Pour plus de détails et faire votre choix parmi les couleurs et les textures, rendez-vous en pages 6 et 7.
Weitere Informationen und eine Auswahl an Farben und Strukturen finden Sie auf den Seiten 6 und 7.
Si desea más información o opciones en colores y texturas, por favor, consulte las páginas 6 y 7.
Per maggiori dettagli e per fare la tua scelta tra colori e trame vai alle pagine 6 e 7.



Oval platter
Plat ovale
Platte oval
Fuente oval
Piatto ovale
NNOP36 36 x 27 cm
14.15 x 10.65"
6



Oval platter
Plat ovale
Platte oval
Fuente oval
Piatto ovale
36 x 27 cm
14.15 x 10.65"



NEOFUSION
■ NFNNOP36BK
■ NFNNOP36DR
■ NFNNOP36GY
■ NFNNOP36WH
6

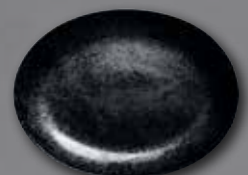

Oval platter
Plat ovale
Platte oval
Fuente oval
Piatto ovale
KARBON
KRNNOP36 36 x 27 cm
14.15 x 10.65"
6

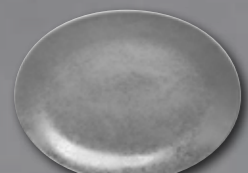

Oval platter
Plat ovale
Platte oval
Fuente oval
Piatto ovale
SHALE
SHNNOP36 36 x 27 cm
14.15 x 10.65"
6



Oval platter
Plat ovale
Platte oval
Fuente oval
Piatto ovale
36 x 27 cm
14.15 x 10.65"



NEOFUSION MELLOW
■ NFNNOP36CB
■ NFNNOP36PG
■ NFNNOP36OL
■ NFNNOP36PP
6



Oval platter
Plat ovale
Platte oval
Fuente oval
Piatto ovale
36 x 27 cm
14.15 x 10.65"

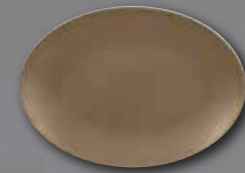

GENESIS MAT
■ GNNNOP36AL
■ GNNNOP36CR
■ GNNNOP36CO
6



Oval platter
Plat ovale
Platte oval
Fuente oval
Piatto ovale
36 x 27 cm
14.15 x 10.65"



TWIRL
■ TWNNOP36BE
■ TWNNOP36SH
■ TWNNOP36AL
■ TWNNOP36CO
■ TWNNOP36LA
6



Oval platter
Plat ovale
Platte oval
Fuente oval
Piatto ovale
36 x 27 cm
14.15 x 10.65"



VINTAGE
■ VNNNOP36WH
■ VNNNOP36GR
■ VNNNOP36BL
■ VNNNOP36PK
6



Oval platter
Plat ovale
Platte oval
Fuente oval
Piatto ovale
36 x 27 cm
14.15 x 10.65"



LEA
■ LENNOP36BL
■ LENNOP36LG
■ LENNOP36RD
■ LENNOP36OR
■ LENNOP36NY
6



Drop shaped platter
Plat en forme de goutte
Platte in Tropfenform
Plato en forma de gota
Piatto a goccia
ACDS01 35.5 x 18.5 cm
14 x 7.30"
6



For more details and to make your choice among colours and textures, please go to pages 6 and 7.
Pour plus de détails et faire votre choix parmi les couleurs et les textures, rendez-vous en pages 6 et 7.
Weitere Informationen und eine Auswahl an Farben und Strukturen finden Sie auf den Seiten 6 und 7.
Si desea más información o opciones en colores y texturas, por favor, consulte las páginas 6 y 7.
Per maggiori dettagli e per fare la tua scelta tra colori e trame vai alle pagine 6 e 7.

MEDIUM DISHES

En

For playful dining experiences, the MEDIUM DISHES series offers a wide range of sizes, shapes, and colours, suitable for all kinds of uses.

Fr

Pour des dégustations enjouées, MEDIUM DISHES propose un large éventail de tailles, de formes et de couleurs adaptées à toutes sortes d'usage.

De

Für raffinierte Degustationen bieten MEDIUM DISHES eine umfangreiche Palette an Größen, Formen und Farben, die für jegliche Nutzung geeignet sind.

Es

Cuando las degustaciones se animan, los MEDIUM DISHES proponen un amplio abanico de tamaños, formas y colores, que se adaptan a todo tipo de usos.

It

Per le degustazioni più vivaci MEDIUM DISHES propone una vasta gamma di dimensioni, forme e colori, adatta ad ogni tipo di usi.



Embossed rectangular platter
Plat rectangulaire mouluré
Platte rechteckig mit Relief-Dekor
Fuente rectangular con relieve
Piatto rettangolare con rilievo

NFSHREP32W 32.5 x 26.5 cm
12.80 x 10.45" GN 1/2

NFSHREP32 32.5 x 17.6 cm
12.80 x 6.95" GN 1/3

6

NFSHREP26 26.5 x 16.2 cm
10.45 x 6.40" GN 1/4

NFSHREP18 17.6 x 16.2 cm
6.95 x 6.40" GN 1/6

12



NEW



Round cocotte & lid
Cocotte ronde & couvercle
Cocotte rund & Deckel
Cocotte redonda & tapa
Cocotte rotonda & coperchio

16 cm - 8 cm - 46.7 cl
6.30" - 3.15" - 15.80 oz

CHEF'S FUSION

■ CFRD16BK

■ CFRD16BR

■ CFRD16GY

4



Round cocotte
Cocotte ronde
Cocotte rund
Cocotte redonda
Cocotte rotonda

16 cm - 5.2 cm - 46.7 cl
6.30" - 2.05" - 15.80 oz

CHEF'S FUSION

■ CFRD16BKBD

■ CFRD16BRBD

■ CFRD16GYBD

4

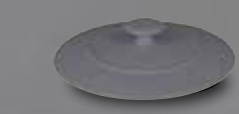

Lid for round cocotte
Couvercle pour cocotte ronde
Deckel für Cocotte rund
Tapa para cocotte redonda
Coperchio per cocotte rotonda

16 cm - 2.8 cm
6.30" - 1.10"

CHEF'S FUSION

■ CFRD16BKLD

■ CFRD16BRLD

■ CFRD16GYLD

6



For more details and to make your choice among colours and textures, please go to pages 6 and 7.
Pour plus de détails et faire votre choix parmi les couleurs et les textures, rendez-vous en pages 6 et 7.
Weitere Informationen und eine Auswahl an Farben und Strukturen finden Sie auf den Seiten 6 und 7.
Si desea más información o opciones en colores y texturas, por favor, consulte las páginas 6 y 7.
Per maggiori dettagli e per fare la tua scelta tra colori e trame vai alle pagine 6 e 7.

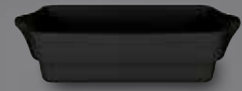

Rectangular tureen
Terrine rectangulaire
Terrine rechteckig
Tarrina rectangular
Terrina rettangolare

19.2 cm - 6 cm - 67 cl
7.55 x 3.95" - 2.35" - 22.65 oz

CHEF'S FUSION

- CFRT20BKBD
- CFRT20BRBD
- CFRT20GYBD

3



Lid for rectangular tureen
Couvercle pour terrine
rectangulaire

Deckel für Terrine rechteckig
Tapa para tarrina rectangular
Coperchio per terrina
rettangolare

20 x 10 cm - 2.5 cm
7.85 x 3.95" - 1"

CHEF'S FUSION

- CFRT20BKLD
- CFRT20BRLD
- CFRT20GYLD

3



Round soup tureen & lid
Soupière ronde & couvercle
Suppenterrine rund & Deckel
Sopera redonda & tapa
Zuppiera rotonda & coperchio

CHEF'S FUSION
15 cm - 14 cm - 115 cl
5.90" - 5.50" - 38.90 oz

- CFST15BK
- CFST15BR
- CFST15GY

10.6 cm - 10.5 cm - 45 cl
4.15" - 4.15" - 15.20 oz

- CFST10BK
- CFST10BR
- CFST10GY

2



Round soup tureen
Soupière ronde
Suppenterrine rund
Sopera redonda
Zuppiera rotonda

CHEF'S FUSION
15 cm - 11 cm - 115 cl
5.90" - 4.35" - 38.90 oz

- CFST15BKBD
- CFST15BRBD
- CFST15GYBD

10.6 cm - 8 cm - 45 cl
4.15" - 3.15" - 15.20 oz

- CFST10BKBD
- CFST10BRBD
- CFST10GYBD

2

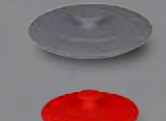

Lid for round soup tureen
Couvercle pour soupière ronde
Deckel für Suppenterrine rund
Tapa para sopra redonda
Coperchio per zuppiera rotonda

CHEF'S FUSION
15 cm - 3 cm
5.90" - 1.20"

- CFST15BKLD
- CFST15BRLD
- CFST15GYLD

6

10.6 cm - 2.5 cm
4.15" - 1"

- CFST10BKLD
- CFST10BRLD
- CFST10GYLD

12



Round soup tureen & lid
Soupière ronde
& couvercle
Suppenterrine rund
& Deckel
Sopera redonda & tapa
Zuppiera rotonda
& coperchio

10.6 cm - 10.5 cm - 45 cl
4.15" - 4.15" - 15.20 oz

GENESIS MAT

- GNCFST10AL
- GNCFST10CR
- GNCFST10CO

2



Pan
Poêlon
Pfanne
Sartén
Tegame

CHEF'S FUSION
24 cm - 4.5 cm
9.45" - 1.75"

- CFPN24BK
- CFPN24BR
- CFPN24GY

16 cm - 3 cm
6.30" - 1.20"

- CFPN16BK
- CFPN16BR
- CFPN16GY

6

12 cm - 2.5 cm
4.70" - 1"

- CFPN12BK
- CFPN12BR
- CFPN12GY

12



Oval dish with grip
Plat à oreilles ovale
Schale oval mit Griffen
Plato oval con asas
Piatto ovale con alette

OPOD25 25 x 14 cm - 42 cl
9.85 x 5.50" - 14.20 oz

24

OPOD24 24 x 13 cm - 32.5 cl
9.45 x 5.10" - 11 oz

OPOD20 20 x 11 cm - 20 cl
7.85 x 4.35" - 6.75 oz

12



Oval dish with grip
Plat à oreilles ovale
Schale oval mit Griffen
Plato oval con asas
Piatto ovale con alette

NEOFUSION
25 x 14 x 4.3 cm - 42 cl
9.85 x 5.50 x 1.70" - 14.20 oz

- NFOPD25BK
- NFOPD25GY

24

20 x 11 x 3.5 cm - 20 cl
7.85 x 4.35 x 1.40" - 6.75 oz

- NFOPD20BK

12



Round dish with grip
Plat à oreilles rond
Schale rund mit Griffen
Plato redondo con asas
Piatto rotondo con alette

OPRD16 21.5 x 18 x 4 cm - 45 cl
8.45 x 7.10 x 1.55" - 15.20 oz

12



Round dish with grip
Plat à oreilles rond
Schale rund mit Griffen
Plato redondo con asas
Piatto rotondo con alette

21.5 x 18 x 4 cm - 45 cl
8.45 x 7.10 x 1.55" - 15.20 oz

NEOFUSION

- NFOPRD16BK
- NFOPRD16GY

12



Noodle bowl
Bol à nouilles
Nudelschale
Noodle bol
Coppetta per pasta

OPNB15 15 cm - 6 cm - 63 cl
5.90" - 2.35" - 21.30 oz

6



Noodle bowl
Bol à nouilles
Nudelschale
Noodle bol
Coppetta per pasta

15 cm - 6 cm - 63 cl
5.90" - 2.35" - 21.30 oz

NEOFUSION

- NFOPNB15BK
- NFOPNB15GY

6



For more details and to make your choice among colours and textures, please go to pages 6 and 7.
Pour plus de détails et faire votre choix parmi les couleurs et les textures, rendez-vous en pages 6 et 7.
Weitere Informationen und eine Auswahl an Farben und Strukturen finden Sie auf den Seiten 6 und 7.
Si desea más información o opciones en colores y texturas, por favor, consulte las páginas 6 y 7.
Per maggiori dettagli e per fare la tua scelta tra colori e trame vai alle pagine 6 e 7.



Salad bowl
Saladier
Salatschale
Ensaladera
Insalatiera

SUGGESTIONS - SHAPED

28 x 23 cm - 4.5 cm - 112 cl
11 x 9.05" - 1.75" - 37.85 oz

- SHSB28
- KRSHSB28

25 x 21 cm - 4.5 cm - 75 cl
9.85 x 8.25" - 1.75" - 25.35 oz

- SHSB25
- KRSHSB25

19 x 15 cm - 4.5 cm - 35 cl
7.50 x 5.90" - 1.75" - 11.85 oz

- SHSB19
- KRSHSB19

14 x 11 cm - 5.5 cm - 27 cl
5.50 x 4.35" - 2.15" - 9.15 oz

- SHSB14
- KRSHSB14

12



NEW

Carved bowl
Bol sculpté
Schale gemeißelt
Bol esculpido
Coppetta scolpita

APCB20 18.5 cm - 7 cm - 21 cl
7.30" - 2.75" - 7.10 oz

2



NEW

Carved bowl
Bol sculpté
Schale gemeißelt
Bol esculpido
Coppetta scolpita

APCB20T 17 cm - 9.5 cm - 53 cl
6.70" - 3.75" - 17.90 oz

1



Double bowl
Bol double
Doppelschale
Bol doble
Coppetta doppia

APDB30 22.5 x 12.5 cm - 7 cm - 30 cl
8.85 x 4.90" - 2.75" - 10.15 oz

3

APDB19 19.5 x 10 cm - 5.5 cm - 19 cl
7.70 x 3.95" - 2.15" - 6.40 oz

6



NEW



Bowl boat
Bol bateau
Bootschale
Bol barco
Coppetta barca

MNSB68 22.5 x 13.5 cm - 8 cm - 68 cl
8.85 x 5.30" - 3.15" - 23 oz

6



Boat dish
Plat bateau
Bootschale
Plato barco
Piatto barca

MNSB44 23 x 13 cm - 5.5 cm - 44 cl
9.05 x 5.10" - 2.20" - 14.90 oz

6



Boat dish
Plat bateau
Bootschale
Plato barco
Piatto barca

MNSB34 21 x 11.5 cm - 5.2 cm - 34 cl
8.20 x 4.55" - 2.05" - 11.50 oz

6



Bowl boat
Bol bateau
Bootschale
Bol barco
Coppetta barca

MNSB32 17 x 10.5 cm - 6.5 cm - 32 cl
6.70 x 4.15" - 2.55" - 10.80 oz

6



Bowl
Bol
Schale
Bol
Coppetta

NAMB27 27 cm - 6.5 cm - 70 cl
10.65" - 2.55" - 23.65 oz

NAMB16 16 cm - 3.5 cm - 12 cl
6.30" - 1.40" - 4.05 oz

24

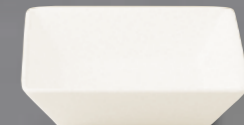

Square bowl
Bol carré
Schale quadratisch
Bol cuadrado
Coppetta quadrata

OPSB15 15 cm - 7 cm - 70 cl
5.90" - 2.75" - 23.65 oz

6

OPSB12 12 cm - 3.5 cm - 20 cl
4.70" - 1.40" - 6.75 oz

24

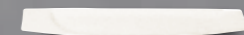

Baguette tray
Plat baguette
Platte baguette
Bandeja baguette
Vassoio baguette

MZBP26 26 x 10 cm
10.25 x 3.95"

6

MZBP20 20 x 7.5 cm
7.85 x 2.95"

12

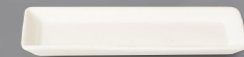

Rectangular tray
Plat rectangulaire
Platte rechteckig
Bandeja rectangular
Vassoio rettangolare

OPRT18 18 x 7.5 cm
7.10 x 2.95"

24



For more details and to make your choice among colours and textures, please go to pages 6 and 7.
Pour plus de détails et faire votre choix parmi les couleurs et les textures, rendez-vous en pages 6 et 7.
Weitere Informationen und eine Auswahl an Farben und Strukturen finden Sie auf den Seiten 6 und 7.
Si desea más información o opciones en colores y texturas, por favor, consulte las páginas 6 y 7.
Per maggiori dettagli e per fare la tua scelta tra colori e trame vai alle pagine 6 e 7.

En

A range of buffet items would not be complete without a multitude of small dishes used to serve small portions. You will find hereafter an answer to all needs in a wide variety of shapes and colours.

Fr

Un assortiment d'articles pour les buffets ne serait pas complet sans une pléiade de petits contenants indispensables au service de petites portions. Vous trouverez ici une réponse à tous les besoins dans une grande diversité de formes et de couleurs.

De

Ein Sortiment von Buffet-Artikeln wäre nicht vollständig ohne eine Vielfalt von Schälchen, die zum Servieren von kleinen Portionen verwendet werden. Hier finden Sie Antworten auf alle Bedürfnisse in verschiedenen Formen und Farben.

Es

Nuestras diferentes colecciones de artículos para buffets no estarían completas sin una gran variedad de pequeños recipientes complementarios necesarios para servir pequeñas raciones. Aquí encontrará la respuesta a todas estas necesidades en forma de una amplia variedad de formas y colores.

It

Un assortimento di articoli per buffet non sarebbe completo senza un gran numero di contenitori adeguati al servizio di piccole porzioni. Qui troverai una risposta a tutte le esigenze e in un'ampia varietà di forme e colori.



Square deep dish
Ravier carré creux
Schale tief quadratisch
Rabanera honda cuadrada
Coppetta fonda quadrata

SUGGESTIONS - STAGED
NFSTSQDD09 9 x 9 cm - 6 cm - 33 cl
3.55 x 3.55" - 2.35" - 11.15 oz

12

NEW



Square dish
Ravier carré
Schale quadratisch
Rabanera cuadrada
Coppetta quadrata

SUGGESTIONS - STAGED
NFSTSED09 6.5 x 6.5 cm - 2.5 cm - 5.2 cl
2.55 x 2.55" - 1" - 1.75 oz

12

NEW



Rectangular dish
Ravier rectangulaire
Schale rechteckig
Rabanera rectangular
Coppetta rettangolare

SUGGESTIONS - STAGED
NFSTREP17 17 x 7 cm - 2.5 cm - 11 cl
6.70 x 2.75" - 1" - 3.7 oz

12

NEW



Round cocotte & lid
Cocotte ronde & couvercle
Cocotte rund & Deckel
Cocotte redonda & tapa
Cocotte rotonda & coperchio

10 cm - 7 cm - 21.6 cl
4" - 2.75" - 7.30 oz

CHEF'S FUSION

■ CFRD10BK
■ CFRD10BR
■ CFRD10GY

12



Round cocotte
Cocotte ronde
Cocotte rund
Cocotte redonda
Cocotte rotonda

10 cm - 5.2 cm - 21.6 cl
4" - 2.05" - 17.30 oz

CHEF'S FUSION

■ CFRD10BKBD
■ CFRD10BRBD
■ CFRD10GYBD

12



Lid for round cocotte
Couvercle pour cocotte ronde
Deckel für Cocotte rund
Tapa para cocotte redonda
Coperchio per cocotte rotonda

10 cm - 1.8 cm
4" - 0.70"

CHEF'S FUSION

■ CFRD10BKLD
■ CFRD10BRLD
■ CFRD10GYLD

12



For more details and to make your choice among colours and textures, please go to pages 6 and 7.
Pour plus de détails et faire votre choix parmi les couleurs et les textures, rendez-vous en pages 6 et 7.
Weitere Informationen und eine Auswahl an Farben und Strukturen finden Sie auf den Seiten 6 und 7.
Si desea más información o opciones en colores y texturas, por favor, consulte las páginas 6 y 7.
Per maggiori dettagli e per fare la tua scelta tra colori e trame vai alle pagine 6 e 7.



Mini cocotte & lid
Mini cocotte & couvercle
Mini Cocotte & Deckel
Mini cocotte & tapa
Mini cocotte & coperchio

8.5 cm - 6 cm - 11.2 cl
3.35" - 2.35" - 3.80 oz

CHEF'S FUSION

- CFRD09BK
- CFRD09BR
- CFRD09GY

12



Mini cocotte
Mini cocotte
Mini Cocotte
Mini cocotte
Mini cocotte

8.5 cm - 4.2 cm - 11.2 cl
3.35" - 1.65" - 3.80 oz

CHEF'S FUSION

- CFRD09BKBD
- CFRD09BRBD
- CFRD09GYBD

12



Lid for mini cocotte
Couvercle pour mini cocotte
Deckel für mini Cocotte
Tapa para mini cocotte
Coperchio per mini cocotte

8.5 cm - 1.8 cm
3.35" - 0.70"

CHEF'S FUSION

- CFRD09BKLD
- CFRD09BRLD
- CFRD09GYLD

12



Ramekin with grooves
Ramequin plissé
Auflaufform gerillt
Ramequin estriado
Stampo scanalato

11 cm - 4.5 cm - 30 cl
4.35" - 1.75" - 10.15 oz

CHEF'S FUSION

- CFRM11BK
- CFRM11BR
- CFRM11GY

12



Ramekin with grooves
Ramequin plissé
Auflaufform gerillt
Ramequin estriado
Stampo scanalato

9 cm - 6.5 cm - 20.5 cl
3.55" - 2.55" - 6.95 oz

CHEF'S FUSION

- CFRM09BK
- CFRM09BR
- CFRM09GY

12



Double ramekin
Ramequin double
Doppelte Auflaufform
Ramequin doble
Stampo doppio

13 x 6 cm - 4 cm
5.10 x 2.35" - 1.55"

CHEF'S FUSION

- CFDR02BK
- CFDR02BR
- CFDR02GY

12



Ramekin with grooves
Ramequin plissé
Auflaufform gerillt
Ramequin estriado
Stampo scanalato

ACRG10 10 cm - 33 cl
3.95" - 11.15 oz

ACRG09 9 cm - 19 cl
3.55" - 6.40"

12



Stackable butter ramekin
Ramequin à beurre empilable
Butterschälchen stapelbar
Platillo para mantequilla apilable
Coppetta da burro impilabile

BABR02 8 cm - 3.5 cm - 10 cl
3.15" - 1.40" - 3.40 oz

12



Stackable butter ramekin
Ramequin à beurre empilable
Butterschälchen stapelbar
Platillo para mantequilla apilable
Coppetta da burro impilabile

8 cm - 3.5 cm - 10 cl
3.15" - 1.40" - 3.40 oz

NEOFUSION

- NFBABR02BK
- NFBABR02BR
- NFBABR02DR
- NFBABR02GY
- NFBABR02WH

12

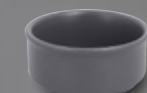

Stackable butter ramekin
Ramequin à beurre empilable
Butterschälchen stapelbar
Platillo para mantequilla apilable
Coppetta da burro impilabile

BABR03 7 cm - 3 cm - 6 cl
2.75" - 1.20" - 2.05 oz

12



Butter ramekin
Ramequin à beurre
Butterschälchen
Platillo para mantequilla
Coppetta da burro

BABR01 6.7 cm - 6 cl / 2.65" - 2.05 oz
BABR05 5 cm / 1.95"

12



For more details and to make your choice among colours and textures, please go to pages 6 and 7.
Pour plus de détails et faire votre choix parmi les couleurs et les textures, rendez-vous en pages 6 et 7.
Weitere Informationen und eine Auswahl an Farben und Strukturen finden Sie auf den Seiten 6 und 7.
Si desea más información o opciones en colores y texturas, por favor, consulte las páginas 6 y 7.
Per maggiori dettagli e per fare la tua scelta tra colori e trame vai alle pagine 6 e 7.



Bowl
Bol
Schale
Bol
Coppetta

SUGGESTIONS - SHAPED

10 x 7.5 cm - 3 cm - 8 cl
4.15 x 2.95" - 1.20" - 2.70 oz

■ SHSB11
■ KRSHSB11

10 x 7.5 cm - 3 cm - 6 cl
3.95 x 2.95" - 1.20" - 2.05 oz

■ SHSB10
■ KRSHSB10

8 x 7 cm - 3 cm - 4.5 cl
3.15 x 2.75" - 1.20" - 1.50 oz

■ SHSB08
■ KRSHSB08

12

NEW



Mini boat bowl
Mini bol bateau
Mini Bootschale
Mini bol barco
Mini coppetta barca

MNOD09 15 x 8.5 cm - 3.5 cm - 11 cl
5.85 x 3.35" - 1.40" - 3.70 oz

6



Miniature round bowl
Miniature bol rond
Miniaturschale rund
Miniatura bol redondo
Miniatura coppetta rotonda

OPCU05 5 dl / 1.70 oz

12



Square bowl
Bol carré
Schale quadratisch
Bol cuadrado
Coppetta quadrata

OPSB09 9 cm - 5 cm - 17 cl
3.55" - 1.95" - 5.75 oz

6

OPSB08 8 cm - 4 cm - 10.5 cl
3.15" - 1.55" - 3.55 oz

12

OPSB07 7 cm - 3.5 cm - 7 cl
2.75" - 1.40" - 2.35 oz

6



Bowl
Bol
Schale
Bol
Coppetta

SPCU18 7.5 cm - 6 cm - 18 cl
2.95" - 2.35" - 6.10 oz

12



Rectangular tray, 3 indents

Plat rectangulaire, 3 empreintes
Platte rechteckig, 3 Ringe
Fuente rectangular, 3 estanques

Vassoio rettangolare, 3 inserti

36 x 10 cm
14.15 x 3.95"

SUGGESTIONS - SHAPED

■ SHRT36
■ KRSHRT36

6

NEW



Cup without handle
Tasse sans anse
Tasse ohne Henkel
Taza sin asa
Tazza senza manici

SPCU09 9 cl / 3.05 oz

12



Cup without handle
Tasse sans anse
Tasse ohne Henkel
Taza sin asa
Tazza senza manici

6 cm - 7 cm - 9 cl
2.35" - 2.75" - 3.05 oz

NEOFUSION

■ NFSPCU09BK

12



Creamer
Crémier
Milchkännchen
Lechera
Bricco da latte

OPCR09M 6 cm - 7.2 cm - 9 cl
2.30" - 2.85" - 3.05 oz

12



High cube
Cube haut
Kubus hoch
Cubo alto
Coppetta a cubo alta

OPSD01 5 cm - 5.5 cm - 9 cl
1.95" - 2.15" - 3.05 oz

12



High cube
Cube haut
Kubus hoch
Cubo alto
Coppetta a cubo alta

5 cm - 5.5 cm - 9 cl
1.95" - 2.15" - 3.05 oz

NEOFUSION

■ NFOPSD01BK

12



Small cube
Cube bas
Kubus klein
Cubo bajo
Coppetta a cubo piccola

OPSD02 5 cm - 4.5 cm - 6 cl
1.95" - 1.75" - 2.05 oz

12



Small cube
Cube bas
Kubus klein
Cubo bajo
Coppetta a cubo piccola

5 cm - 4.5 cm - 6 cl
1.95" - 1.75" - 2.05 oz

NEOFUSION

■ NFOPSD02BK

12



Square creamer/ gravy boat

Crémier/saucière carré
Saucière/Milchkännchen quadratisch
Salsera/lechera cuadrada
Salsiera/bricco da latte quadrato

OPSD03 5 cm - 6 cm - 8 cl
1.95" - 2.30" - 2.70 oz

12



Square creamer/ gravy boat

Crémier/saucière carré
Saucière/Milchkännchen quadratisch
Salsera/lechera cuadrada
Salsiera/bricco da latte quadrato

5.3 cm - 5.8 cm - 8 cl
2.10" - 2.30" - 2.70 oz

NEOFUSION

■ NFOPSD03BK

■ NFOPSD03GY

■ NFOPSD03WH

12



For more details and to make your choice among colours and textures, please go to pages 6 and 7.
Pour plus de détails et faire votre choix parmi les couleurs et les textures, rendez-vous en pages 6 et 7.
Weitere Informationen und eine Auswahl an Farben und Strukturen finden Sie auf den Seiten 6 und 7.
Si desea más información o opciones en colores y texturas, por favor, consulte las páginas 6 y 7.
Per maggiori dettagli e per fare la tua scelta tra colori e trame vai alle pagine 6 e 7.



Square sauce dish
Bol à sauce carré
Saucenschale quadratisch
Bol salsa cuadrado
Salsiera quadrata

ACSD01 7.5 cm - 3 cm
2.95" - 1.20"



Mini pan with grip
Mini poêlon avec poignée
Mini Pfanne mit Griff
Mini sartén con asa
Mini tegame

MNMP01 6.2 cm / 2.45"



Miniature triangular boat
Miniature bateau
triangulaire
Miniatur Boot dreieckig
Miniatura barco triangular
Miniatura barca triangolare

MNTD01 7.5 x 6 cm - 3 cm
2.95 x 2.35" - 1.20"



Cone
Cornet
Schale konisch
Cucurucho
Cono

PICT10 10 cm - 17.5 cm
3.95" - 6.90"



PICT9 9 cm - 12.5 cm
3.55" - 4.90"



PICT7 7 cm - 12 cm
2.75" - 4.70"



NEW



Miniature square boat
Miniature bateau carré
Miniatur Boot quadratisch
Miniatura barco cuadrado
Miniatura barca quadrata

MNSD01 6 cm - 3 cm - 6 cl
2.35" - 1.20" - 2.05 oz



Cone holder - stainless steel
Support pour cornet - acier inoxydable
Schale konisch Halter - Edelstahl
Soporte per cucurucho - acero inoxidable
Supporto para cono - acciaio inossidabile

PIRC08 8 cm - 7 cm
3.15" - 2.75"



NEW



Asymmetric dish
Coupelle asymétrique
Schale asymmetrisch
Bol asimétrico
Coppetta asimmetrica

OPAB06 6 cm - 2 cm
2.35" - 0.80"



Egg cup
Coquetier
Eierbecher
Huevera
Portauovo

OPEG01



Pieces per box
Pièces par boîte
Stück pro Karton
Piezas por caja
Pezzi per scatola



GASTRONORM DISHES

En

The "gastronorm" range of dishes boasts high technical performance. White or decorated, these dishes stand up to any test.

Fr

La gamme de plats « gastronorm » possède une performance technique élevée. Blancs ou décorés, ces plats résistent à toute épreuve.

De

Die Schalen aus der Reihe „Gastronorm“ bieten hohe technische Leistungen. Ob in Weiß oder mit Dekor, diese Schalen halten jeder Beanspruchung stand.

Es

La gama de fuentes "gastronorm" destaca por sus altas prestaciones técnicas. Blancas o decoradas, estas fuentes resisten las pruebas más duras.

It

La gamma dei piatti « gastronorm » vanta alte prestazioni tecniche. Bianchi o decorati, questi piatti resistono a qualsiasi prova.



Embossed rectangular platter
Plat rectangulaire mouluré
Platte rechteckig mit Relief-Dekor
Fuente rectangular con relieve
Piatto rettangolare con rilievo

SUGGESTIONS - SHARED

NFSHREP32W 32.5 x 26.5 cm
12.80 x 10.45"

NFSHREP32 32.5 x 17.6 cm
12.80 x 6.95"

6



NEW



Embossed rectangular platter
Plat rectangulaire mouluré
Platte rechteckig mit Relief-Dekor
Fuente rectangular con relieve
Piatto rettangolare con rilievo

SUGGESTIONS - SHARED

NFSHREP26 26.5 x 16.2 cm
10.45 x 6.40"

NFSHREP18 17.6 x 16.2 cm
6.95 x 6.40"

12



NEW

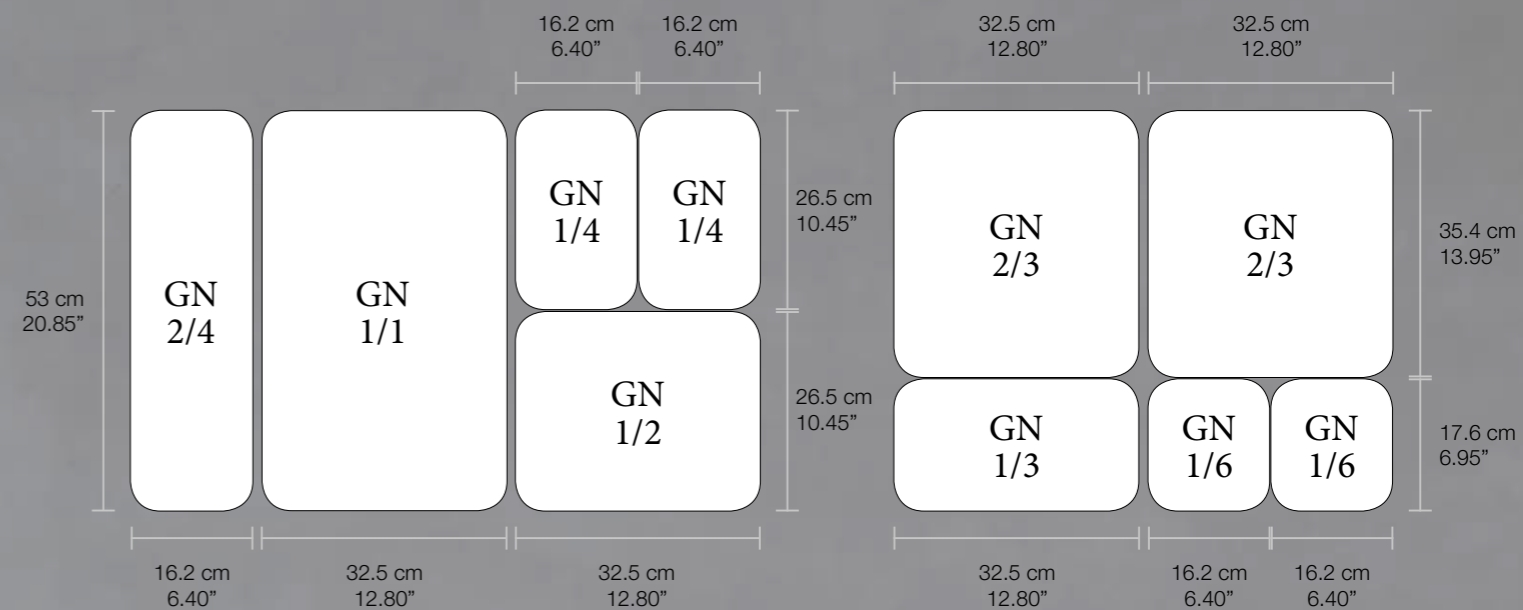

1/1

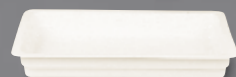

Gastronorm pan
Plat Gastronorm
Schale Gastronorm
Fuente Gastronorm
Contentitore Gastronorm

BUGN1.1 53 x 32.5 x 6.5 cm - 730 cl
20.85 x 12.80 x 2.55" - 246.85 oz



1/2



Gastronorm pan
Plat Gastronorm
Schale Gastronorm
Fuente Gastronorm
Contentitore Gastronorm

BUGN1.2 32.5 x 26.5 x 6.5 cm - 330 cl
12.80 x 10.45 x 2.55" - 111.60 oz



1/3

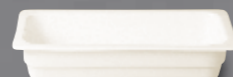

Gastronorm pan
Plat Gastronorm
Schale Gastronorm
Fuente Gastronorm
Contentitore Gastronorm

BUGN1.3 32.5 x 17.6 x 6.5 cm - 200 cl
12.80 x 6.95 x 2.55" - 67.65 oz



2/4

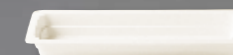

Gastronorm pan
Plat Gastronorm
Schale Gastronorm
Fuente Gastronorm
Contentitore Gastronorm

BUGN2.4 53 x 16.2 x 6.5 cm - 260 cl
20.85 x 6.40 x 2.55" - 87.90 oz



Gastronorm pan
Plat Gastronorm
Schale Gastronorm
Fuente Gastronorm
Contentitore Gastronorm

53 x 32.5 x 6.5 cm - 730 cl
20.85 x 12.80 x 2.55" - 246.85 oz

NEOFUSION

- NFBU1.1BK
- NFBU1.1DR
- NFBU1.1GY



Gastronorm pan
Plat Gastronorm
Schale Gastronorm
Fuente Gastronorm
Contentitore Gastronorm

32.5 x 26.5 x 6.5 cm - 330 cl
12.80 x 10.45 x 2.55" - 111.60 oz

NEOFUSION

- NFBU1.2BK
- NFBU1.2DR
- NFBU1.2GY

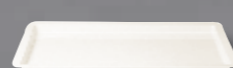

Gastronorm pan
Plat Gastronorm
Schale Gastronorm
Fuente Gastronorm
Contentitore Gastronorm

BUGN1.3F 32.5 x 17.6 x 2 cm - 79 cl
12.80 x 6.95 x 0.80" - 26.70 oz

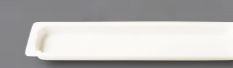

Gastronorm pan
Plat Gastronorm
Schale Gastronorm
Fuente Gastronorm
Contentitore Gastronorm

BUGN2.4F 53 x 16.2 x 2 cm - 125 cl
20.85 x 6.40 x 0.80" - 42.25 oz



2/3



Gastronorm pan
Plat Gastronorm
Schale Gastronorm
Fuente Gastronorm
Contentitore Gastronorm

BUGN2.3 32.5 x 35.4 x 6.5 cm - 478 cl
12.80 x 13.95 x 2.55" - 161.65 oz



Round gastronorm pan
Plat Gastronorm rond
Schale Gastronorm rund
Fuente Gastronorm
redondo
Contentitore Gastronorm
rotondo

BUGN39 39 x 6.2 cm - 433 cl
15.35 x 2.45" - 146.40 oz

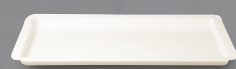

Gastronorm pan
Plat Gastronorm
Schale Gastronorm
Fuente Gastronorm
Contentitore Gastronorm

BUGN1.1F 53 x 32.5 x 2 cm - 220 cl
20.85 x 12.80 x 0.80" - 74.40 oz

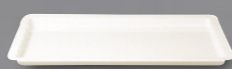

Gastronorm pan
Plat Gastronorm
Schale Gastronorm
Fuente Gastronorm
Contentitore Gastronorm

BUGN1.2F 32.5 x 26.5 x 2 cm - 130 cl
12.80 x 10.45 x 0.80" - 43.95 oz

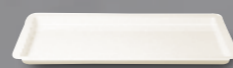

Gastronorm pan
Plat Gastronorm
Schale Gastronorm
Fuente Gastronorm
Contentitore Gastronorm

BUGN2.3F 32.5 x 35.4 x 2 cm - 188 cl
12.80 x 13.95 x 0.80" - 63.65 oz



**Round divided
Gastronorm pan**
Plat Gastronorm
rond divisé
Schale Gastronorm
rond geteilt
Fuente Gastronorm
redondo dividido
Contentitore Gastronorm
rotondo con divisione

BUGN39D 39 x 6.2 cm - 400 cl
15.35 x 2.45" - 135.25 oz



Gastronorm pan
Plat Gastronorm
Schale Gastronorm
Fuente Gastronorm
Contentitore Gastronorm

53 x 32.5 x 2 cm - 220 cl
20.85 x 12.80 x 0.80" - 74.40 oz

NEOFUSION

- NFBU1.1FBK



Gastronorm pan
Plat Gastronorm
Schale Gastronorm
Fuente Gastronorm
Contentitore Gastronorm

32.5 x 26.5 x 2 cm - 130 cl
12.80 x 10.45 x 0.80" - 43.95 oz

NEOFUSION

- NFBU1.2FBK



For more details and to make your choice among colours and textures, please go to pages 6 and 7.
Pour plus de détails et faire votre choix parmi les couleurs et les textures, rendez-vous en pages 6 et 7.
Weitere Informationen und eine Auswahl an Farben und Strukturen finden Sie auf den Seiten 6 und 7.
Si desea más información o opciones en colores y texturas, por favor, consulte las páginas 6 y 7.
Per maggiori dettagli e per fare la tua scelta tra colori e trame vai alle pagine 6 e 7.

1/1



Gastronorm pan
Plat Gastronom
Schale Gastronom
Fuente Gastronom
Contenitore Gastronom

ZMGN1.1 53 x 32.5 x 6.5 cm
20.85 x 12.80 x 2.55"

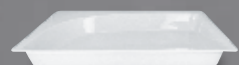

2/3



Divided gastronorm pan
Plat Gastronom divisé
Schale Gastronom geteilt
Fuente Gastronom dividido
Contenitore Gastronom con divisione

ZMGN2.3D 35.4 x 32.5 x 6.5 cm
13.95 x 12.80 x 2.55"



2/4



Divided gastronorm pan
Plat Gastronom divisé
Schale Gastronom geteilt
Fuente Gastronom dividido
Contenitore Gastronom con divisione

ZMGN2.4D 53 x 16.2 x 6.5 cm
20.85 x 6.40 x 2.55"

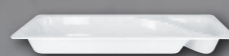

1/2



Gastronorm pan
Plat Gastronom
Schale Gastronom
Fuente Gastronom
Contenitore Gastronom

ZMGN1.2 32.5 x 26.5 x 6.5 cm
12.80 x 10.45 x 2.55"

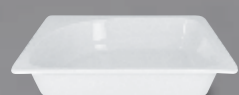

1/3



Divided gastronorm pan
Plat Gastronom divisé
Schale Gastronom geteilt
Fuente Gastronom dividido
Contenitore Gastronom con divisione

ZMGN1.3D 32.5 x 17.6 x 6.5 cm
12.80 x 6.95 x 2.55"



 Pieces per box
Pièces par boîte
Stück pro Karton
Piezas por caja
Pezzi per scatola



En

Whether to give height, to offer modularity to presentations or to suggest ideas for flying buffet tastings, BUFFET SYSTEMS offers the right solution.

Fr

Que ce soit pour donner de la hauteur, offrir de la modularité aux présentations ou pour suggérer des idées pour les dégustations en « flying buffet », BUFFET SYSTEMS offre la bonne solution.

De

Das BUFFET SYSTEMS Sortiment bietet mit seinem ausgefeilten Baukastensystem Lösungen für alle erdenklichen Präsentationsmöglichkeiten wie zum Beispiel ein Flying Buffet.

Es

Ya sea para ofrecer presentaciones a cierta altura, ofrecer presentaciones modulares o sugerir ideas para realizar pruebas de buffet, BUFFET SYSTEMS le ofrece la solución más adecuada.

It

Che sia per dare altezza, offrire modularità alle presentazioni o suggerire idee per degustazioni a buffet, BUFFET SYSTEMS offre la soluzione giusta.



Platter

Plat
Platte
Fuente
Vassoio

LXBS51 51 x 30 cm
20.10 x 11.80"

LXBS30 30 x 26 cm
11.80 x 10.25"

4



Large wooden stand

Support bois grand modèle
Holzständer groß
Soporte de madera grande
Supporto in legno modello grande

WS51 51 x 30 cm
20 x 11.80"

1



Small wooden stand

Support bois petit modèle
Holzständer klein
Soporte de madera pequeño
Supporto in legno modello piccolo

WS30 30 x 26 cm
11.80 x 10.25"

1

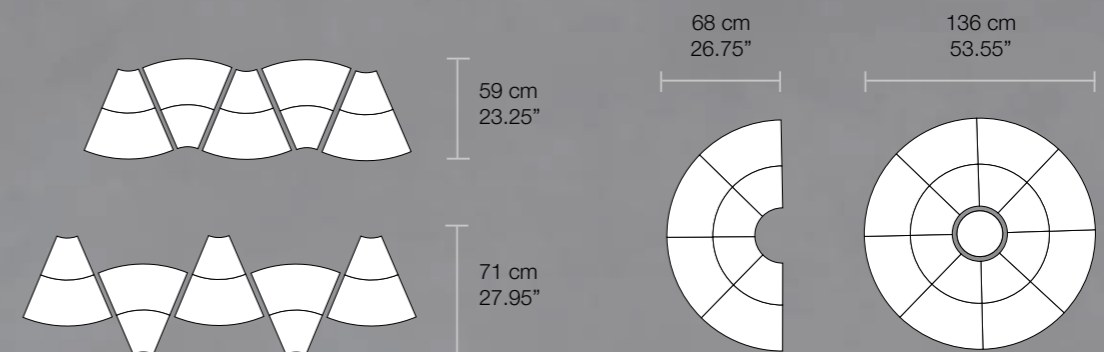

En

Support of varnished wood withstanding abrasion and mechanical shocks, available with 3 sets bases to screw on, 3 heights: 5 cm, 10 cm and 14 cm / 1.95", 3.95" and 5.50"

Fr

Support en bois vernis résistant à l'abrasion et aux chocs mécaniques, livré avec 3 jeux de pieds à visser, 3 hauteurs: 5 cm, 10 cm et 14 cm / 1.95", 3.95" et 5.50"

De

Träger aus lackiertem Holz, das Verschleißerscheinungen und mechanischen Stößen standhält, lieferbar mit 3 Fußsätzen zum Anschrauben, 3 Maße: 5 cm, 10 cm und 14 cm / 1.95", 3.95" und 5.50"

Es

Soporte de madera barnizada, resistente a la abrasión y a los choques mecánicos, se entrega con 3 juegos de papas enroscables, de 3 alturas: 5 cm, 10 cm y 14 cm / 1.95", 3.95" y 5.50"

It

Supporto legno verniciato, resistente all'abrasione e shock meccanico viene consegnato con 3 set di piedi, 3 altezze: 5 cm, 10 cm y 14 cm / 1.95", 3.95" y 5.50"



NEW

Platter
Plat
Platte
Fuente
Vassoio

LXBP30 29.5 x 20 cm
11.60 x 7.85"

6



NEW

Wooden tray
Plateau en bois
Holzplatte
Fuente de madera
Vassoio in legno modello

WDTR65 65.5 cm / 25.80"

1



NEW

Round deep platter
Plat creux rond
Platte tief rund
Fuente hondo redondo
Piatto fondo rotondo

AMDP29 29 cm - 2.5 cm
11.40" - 1"

6

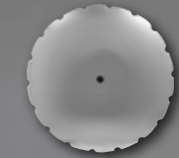

NEW

Serrated round tray
Plat dentelé rond
Platte zackig rund
Fuente dentado redondo
Piatto dentato rotondo

AMTRI26 26 cm / 10.25"

24



NEW

Round flat tray
Plat rond plat
Platte flach rund
Fuente llano redondo
Piatto piano rotondo

AMFLT26 26 cm - 1 cm
10.25" - 0.40"

12



NEW

Riser for platter
Support pour plat
Ständer für Platte
Soporte para fuente
Supporto per piatto

AMRFP30 35 cm - 12 cm
13.80" - 4.70"

1



NEW

Round deep platter
Plat creux rond
Platte tief rund
Fuente hondo redondo
Piatto fondo rotondo

AMDP20 20 cm - 3.5 cm
7.85" - 1.40"

12



NEW

Serrated round tray
Plat dentelé rond
Platte zackig rund
Fuente dentado redondo
Piatto dentato rotondo

AMTRI16 16 cm / 6.30"

24



NEW

Round deep platter
Plat creux rond
Platte tief rund
Fuente hondo redondo
Piatto fondo rotondo

AMDP32 32.5 cm - 6.5 cm
12.80" - 2.55"

3

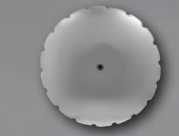

NEW

Serrated round tray
Plat dentelé rond
Platte zackig rund
Fuente dentado redondo
Piatto dentato rotondo

AMTRI16 16 cm / 6.30"

24



NEW

PORCELAIN:
LXBP30 & NNDP23



AMDP29 & AMFLT26

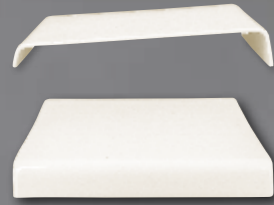

Standing rectangular platter
 Plat rectangulaire surélevé
 Platte rechteckig erhöht
 Fuente rectangular elevado
 Piatto rettangolare elevato

SHSRP35 34.5 x 25 cm - 5.5 cm
 13.60 x 9.85" - 2.15"

SHSRP32 32 x 15 cm - 5.5 cm
 12.60 x 5.90" - 2.15"

SHSRP25 25 x 20 cm - 5.5 cm
 9.85 x 7.85" - 2.15"



NEW



Cone
 Cornet
 Schale konisch
 Cucurucho
 Cono

PICT10 10 cm - 17.5 cm
 3.95" - 6.90"

PICT9 9 cm - 12.5 cm
 3.55" - 4.90"



PICT7 7 cm - 12 cm
 2.75" - 4.70"



NEW



Cone holder - stainless steel
 Support pour cornet - acier inoxydable
 Schale konisch Halter - Edelstahl
 Soporte per cucurucho - acero inoxidable
 Supporto para cono - acciaio inossidabile

PIRC08 8 cm - 7 cm
 3.15" - 2.75"



NEW

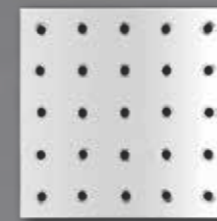

Base for 25 cones - stainless steel
 Support pour 25 cornets - acier inoxydable
 Ständer für 25 Schalen konisch - Edelstahl
 Soporte per 25 cucuruchos - acero inoxidable
 Supporto para 25 coni - acciaio inossidabile

PIBC50 50 x 50 cm - 6.5 cm
 19.70 x 19.70" - 2.55"



NEW



Base for 4 cones - acrylic
 Support pour 4 cornets - acrylique
 Ständer für 4 Schalen konisch - Acryl
 Soporte per 4 cucuruchos - acrilico
 Supporto para 4 coni - acrilico

PIBC41 41 x 11 cm - 6 cm
 16.15 x 4.35" - 2.35"



NEW



Party plate
 Assiette cocktail
 Cocktailteller
 Plato cóctel
 Piatto cocktail

NBPP22 22 x 15.5 cm
 8.65 x 6.10"



SERVICE ACCESSORIES

En

Manufactured in 18-10 stainless steel, these service utensils ensure perfect ergonomics.

Fr

Fabriqués en acier inoxydable 18-10, les ustensiles de service assurent une ergonomie parfaite.

De

Das Servierzubehör aus Edelstahl 18-10 gewährleistet perfekte Ergonomie.

Es

Fabricados en acero inoxidable 18-10, los cubiertos de servicio garantizan una ergonomía perfecta.

It

Realizzate in acciaio inossidabile 18-10, le posate speciali da portata, garantiscono un'ergonomia perfetta.



Serving spoon
Cuillère de service
Servierlöffel
Cuchara servir
Cucchiaione
CANSES 26.9 cm / 10.60"
12



Serving spoon
Cuillère de service
Servierlöffel
Cuchara servir
Cucchiaione
CBASES 26 cm / 10.25"
12



Serving fork
Fourchette de service
Serviergabel
Tenedor servir
Forchettone
CANSEF 26.8 cm / 10.55"
12



Serving fork
Fourchette de service
Serviergabel
Tenedor servir
Forchettone
CBASEF 26 cm / 10.25"
12



Soup ladle
Louche
Suppenschöpfer
Cazo sopa
Mestolo
CANSOL 29 cm / 11.40"
12



Soup ladle
Louche
Suppenschöpfer
Cazo sopa
Mestolo
CBASOL 28.9 cm / 11.40"
12



Gravy ladle
Cuillère à sauce
Saucenlöffel
Cazo salsa
Mestolo salsa
CANGRL 17.8 cm / 7"
12



Gravy ladle
Cuillère à sauce
Saucenlöffel
Cazo salsa
Mestolo salsa
CBAGRL 15.3 cm / 6"
12



Cake server
Pelle à tarte
Tortenheber
Pala tarta
Pala torta
CANCAS 24.7 cm / 9.70"
12



Cake server
Pelle à tarte
Tortenheber
Pala tarta
Pala torta
CBACAS 24.7 cm / 9.70"
12



Menu label holder (porcelain)
Porte-menu (porcelaine)
Menühalter (Porzellan)
Soporte menú (porcelana)
Portamenu (porcellana)
BAMH01 10.5 cm - 7.5 cm
4.15" - 2.95"
12

MAKE SURE
IT'S RAK



CONCEPT AND GRAPHIC DESIGN BY IERACE | DECHMANN + PARTNERS

PHOTO CREDITS:
JOACHIM STRETZ FUENF.6, MATTHIEU CELLARD & ETIENNE DELORME

PRINTED BY: KRÜGER DRUCK + VERLAG

RAK PORCELAIN CHAPTERS COLLECTIONS OVERVIEW

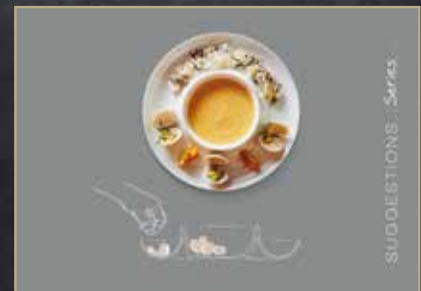
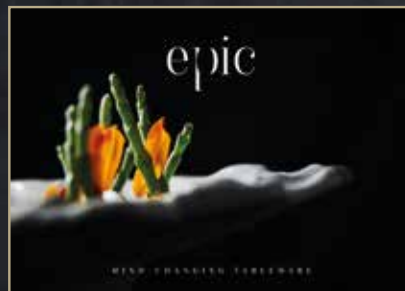

Follow us!



RAK Porcelain LLC
P.O. Box - 30113 - Ras Al Khaimah
United Arab Emirates

T +971 7 223 8905
F +971 7 223 8311

rakporcelain@rakporcelain.com
www.rakporcelain.com

RAK Porcelain Europe S.A.
20, rue de l'Industrie
L-8399 Windhof - Luxembourg

T (+352) 26 36 06 65
F (+352) 26 36 04 65

info@rakporcelaineurope.com
www.rakporcelain.eu

RAK Porcelain USA
595 Route 25A, Suite 17
Miller Place, NY 11764 - USA

T- +1 (866)-552-6980

info@rakporcelainusa.com
www.rakporcelainusa.com